

4G天线

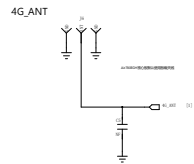

Air780EPM

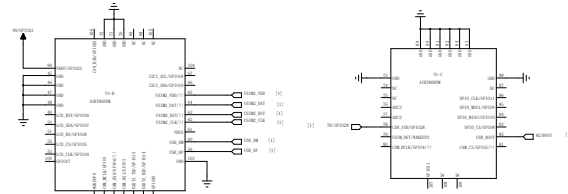
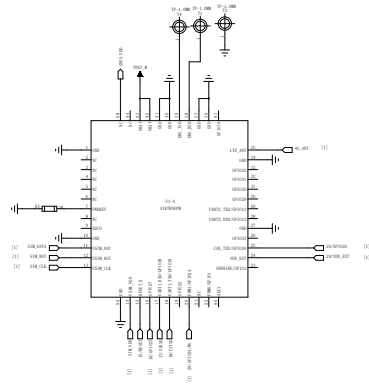

SIM卡座

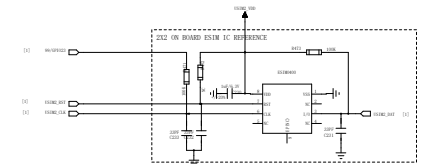
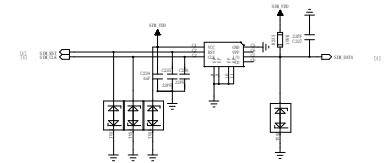

看门狗153C

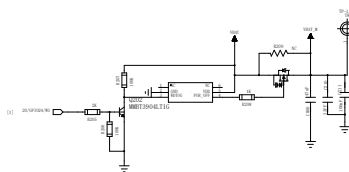

排针

左侧

右侧

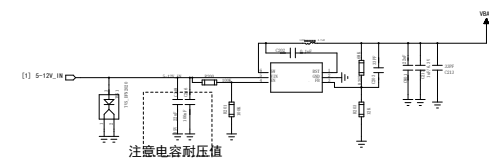
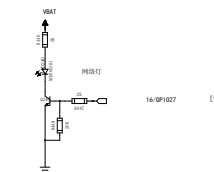
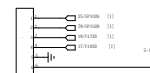
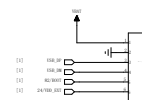

$V_{OUT} = 0.6 * (1 + R202/R203) = 4.0V$

合宙LuatOS					
Air8781P工业模组					
DATE:	ZhuFengyan	DATE:	2025-5-22	DESIGNER:	
DATE:	LuKangsheng	DATE:	2025-5-26	DESIGNER:	
DATE:	LuKangsheng	DATE:	2025-5-26	DESIGNER:	
DATE:	LuKangsheng	DATE:	2025-5-22	DESIGNER:	